

## ECO MIDI KG/FG



User manual

**GRAM**



Gram Commercial A/S  
Aage Grams Vej 1  
6500 Vojens  
+45 73 20 12 00  
[www.gram-commercial.com](http://www.gram-commercial.com)

## Contents

Application.....	4
Safety information .....	5
Location.....	6
General description .....	8
Electrical connection .....	9
General use.....	10
Operating the product.....	12
Temperature setting .....	13
Keyboard lock .....	13
Alarms .....	14
Error codes on the display.....	15
Troubleshooting .....	16
Defrosting.....	18
Defrost water .....	19
Door closing mechanism .....	20
Power failure .....	20
Cleaning .....	20
Door gaskets .....	21
Long term storage .....	21
Service .....	22
Disposal .....	23
EC-Declaration of conformity .....	24
Wiring diagram .....	25

## **ENGLISH**

Thank you for choosing a quality product from Gram Commercial.

This manual will advise you how to install, use and maintain your new product.

Before our products leave the factory, they undergo a full function and quality test. Should you nevertheless experience problems with the product, then contact your local dealer.

Gram Commercial subsidiaries and dealers placed all over the world are ready to help you.

Gram Commercial supplies warranty on all products.

This warranty is subject to correct use according to specifications, where e.g. common maintenance and eventual repairs are carried out by Gram Commercial technicians or technicians with knowledge of the products.

Changes in installation and other use of the product than prescribed in this manual, might affect the operation and durability of the product.

The manual is written according to our current technical knowledge. We constantly work on updating this information, and we reserve the right to make technical changes.

## **Application**

This product is designed for storage of foodstuff at a constant temperature. The product may not be used for chilling or freezing of foodstuff.

The product is only to be used for the purpose for which it has been expressly designed. Any other use could cause that the products stored in the product are not kept at the right temperature.

The manufacturer will not be held liable or responsible for any damage caused by improper, incorrect or unreasonable use.

## Safety information

### ***Important***

Description of symbols used in this manual.



**Warning** Lacking observation to these instructions might result in accidents with personal injury.



**Important** If these instructions are not observed, the product might be damaged or destroyed.

Be aware that Gram Commercial has taken precautions to ensure that the safety of the product is in order.

### ***Please read carefully the following information regarding safety.***



It is important, that everyone who are to use or install the product, to have access to this manual.



This appliance is not intended for use by persons with reduced physical, sensory or mental capabilities, or lack of experience and knowledge, unless they have been given supervision or instruction concerning use of the appliance by a person responsible for their safety.



Children should be supervised to ensure that they do not play with the appliance.



The appliance might contain parts with sharp edges in the compressor compartment, and in the inside compartment.



The appliance is not to be transported on a sack truck, there is a danger of loosing the balance, causing danger to persons.



Do not pull the power cord to dicconnect the appliance, or when moving the appliance.

## Location

When receiving the product, check the packaging material for damage.

If any damage occurs at the packaging material, it should be considered if the product might have been damaged too. If the damage is substantial, please contact your dealer.

The transport pallet can be removed by loosening the screws that fasten the pallet to the product.



This task requires at least 2 persons. The heaviest part of the product is at the bottom. Be aware of this, when removing the transport pallet.

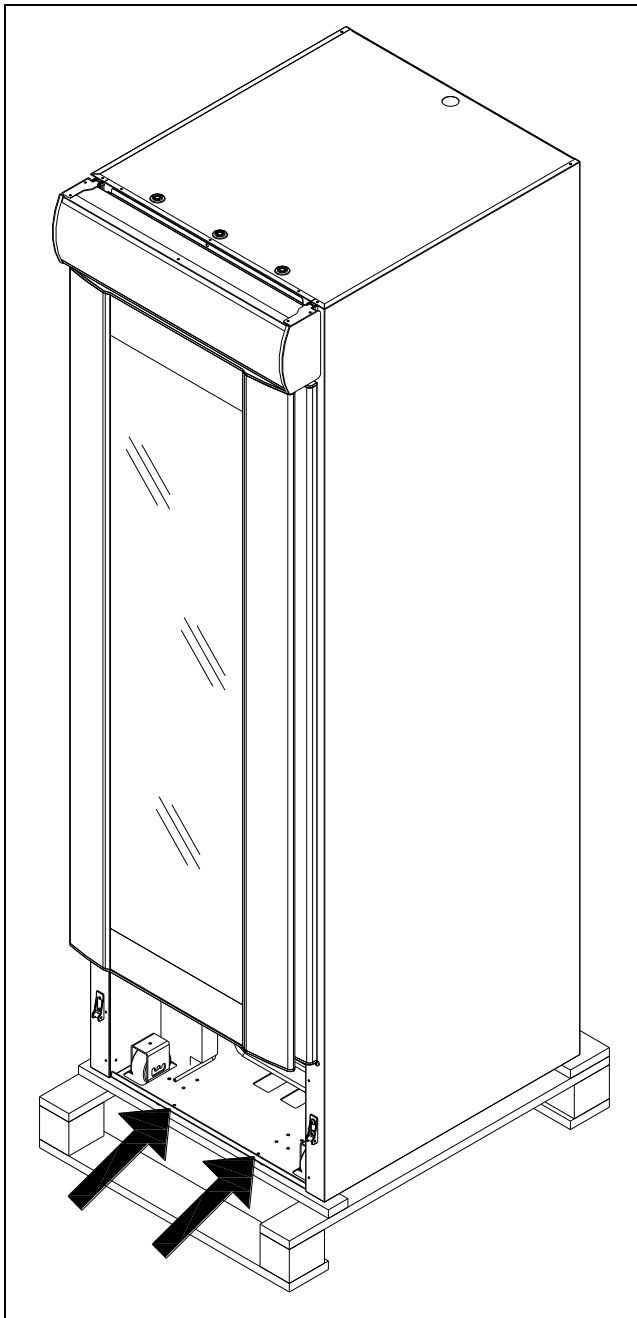

Fig.1



If the cabinet has been transported in horizontal position it must stand upright at least 2 hours before it is started to allow the oil from the compressor to run back. Because of the heavy weight of the product, the floor might be damaged or scratched when moving the product.

Correct set up gives the most effective operation.

The product should be located in a dry and adequately ventilated room.

To ensure efficient operation, it may not be placed in direct sunlight or against heat-emitting surfaces. The product is designed to operate in an ambient temperature between +16°C and +40°C.

Avoid placement of the product in a chlorine/acid-containing environment (swimming bath etc.) due to risk of corrosion.

The product and parts of the interior is equipped with a protecting film, which should be removed before use.

Clean the product with a mild soap solution before use.

The set up place must be level and horizontal.

For versions with legs, use the adjustable legs to make sure that the product stands level and upright.

For versions with castors, the locking devices of the two front castors must be activated, when the product is in place. The base must be level, and the product may not be placed on frames or the like.

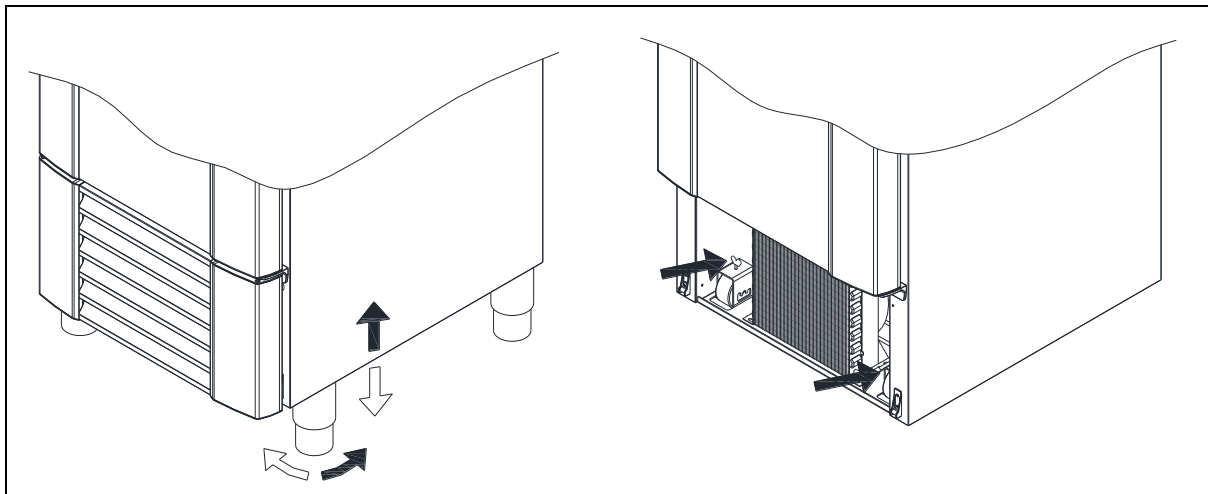

Fig. 2

## General description

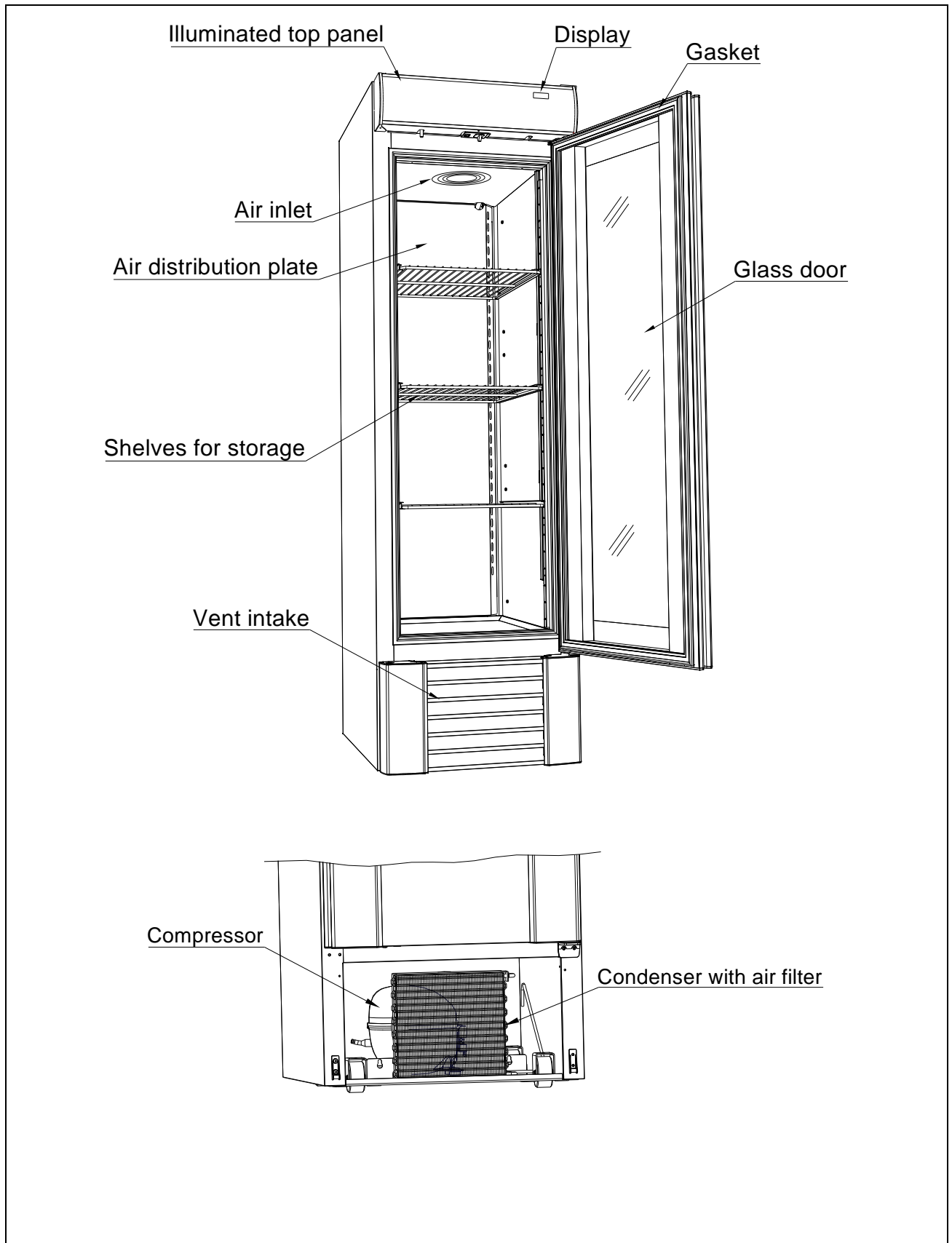

Fig. 3



## Electrical connection

Read the text below thoroughly before electrical connection.



The product is intended for connection to alternating current. The connection voltage (V) and frequency (Hz) are shown on the name plate in the cabinet (see Fig. 8). Only the supplied cord is to be used.



Never use an extension cord for this appliance!  
If a wall socket is placed in a longer distance than the length of the supplied power cord, contact an electrician to establish a wall socket within the range of the supplied power cord.



If the product is defective, it must be examined by a service electrician advised by Gram Commercial during the guarantee period, if it is a product with built-in compressor.

If it is a product connected to an external compressor unit, it must be examined by the company who has connected the product to the unit.

Outside the guarantee period, it is advisable to use the service advised by Gram Commercial, if possible. If this is not the case, assistance is required from a refrigeration company with knowledge of Gram's products.

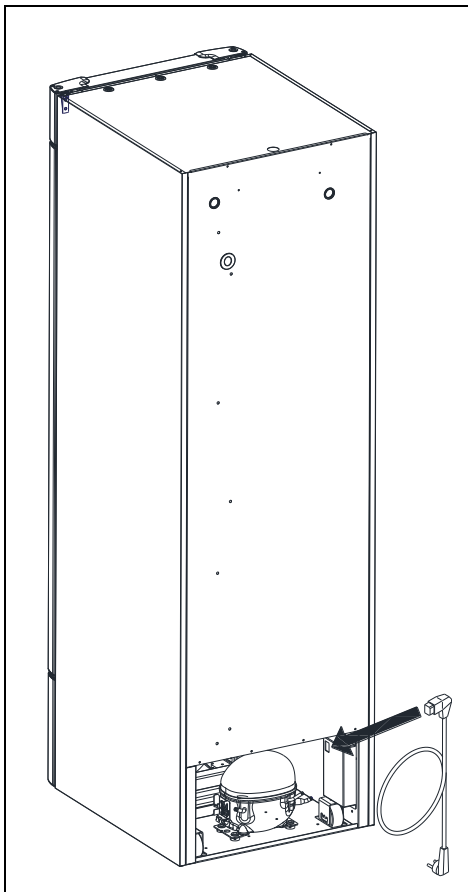

Fig. 4

Always disconnect the power if interruptions in power supply occur, and when electrical parts are removed/put on, and before cleaning and maintenance of the product.

Repairing of electrical/technical parts may only be performed by a service electrician from Gram Commercial or an authorised refrigeration company with knowledge of Gram's products.

Do not use the product before all coverings are installed, so that live or rotating machine parts can not be touched.

The product is not to be used outdoor.

All earthing requirements stipulated by the local electricity authorities must be observed. The plug and wall socket should then give correct earthing. If necessary, contact an electrician.



Make sure the product is switched off at the socket before service is performed on electrical parts. It is not sufficient to switch off the product by the START/STOP key as there will still be voltage to some electrical parts of the product.

## General use



Do not block vent holes in the front panel.



Do not damage the refrigeration system parts.



During normal operation, some parts of the refrigeration system in the compressor compartment might reach high temperatures, and could therefore cause burns if touching these components.



Do not use electrical devices inside the product.



To ensure correct and efficient air flow in the cabinet, the shaded areas must be kept free of items. (see Fig. 5)



All items to be stored, that are not wrapped or packed, must be covered in order to avoid unnecessary corrosion of the inner parts of the cabinet.



If any controller parameters are changed from default, this could cause that the product is not functioning normally, and harmful temperatures could damage items that are kept inside the product.



If the product is turned off, wait minimum 3 minutes before turning it on again. This is to protect the compressor from damage

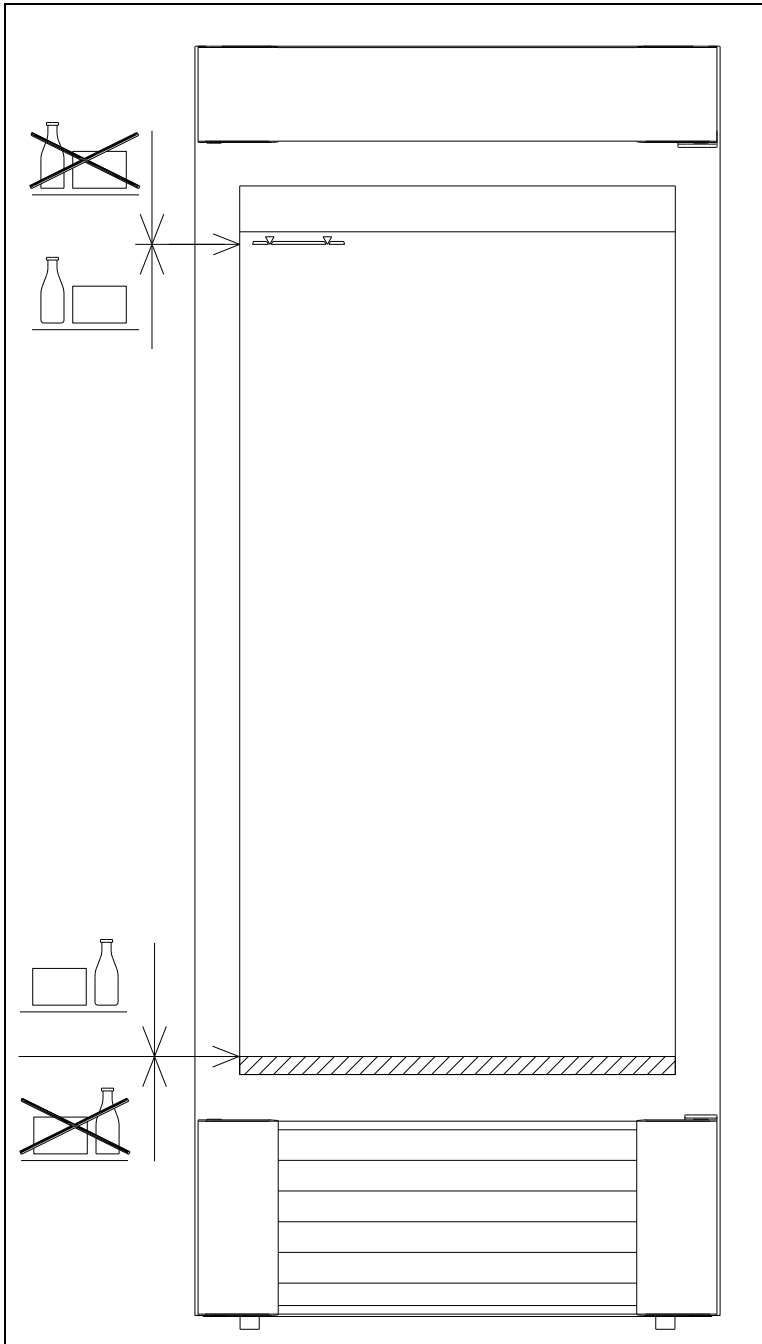

Fig. 5

## Operating the product

Connect the product to the socket. This is done by mounting the accompanying power cord first as shown in Fig. 4, and then subsequently connecting the cord to the socket.

To switch the product on and set the desired temperature for the cabinet, the uppermost panel must be flipped up and held in that position.

**NOTE:** Note that the panel does not stay up by itself, but rather must be held up when it is opened.

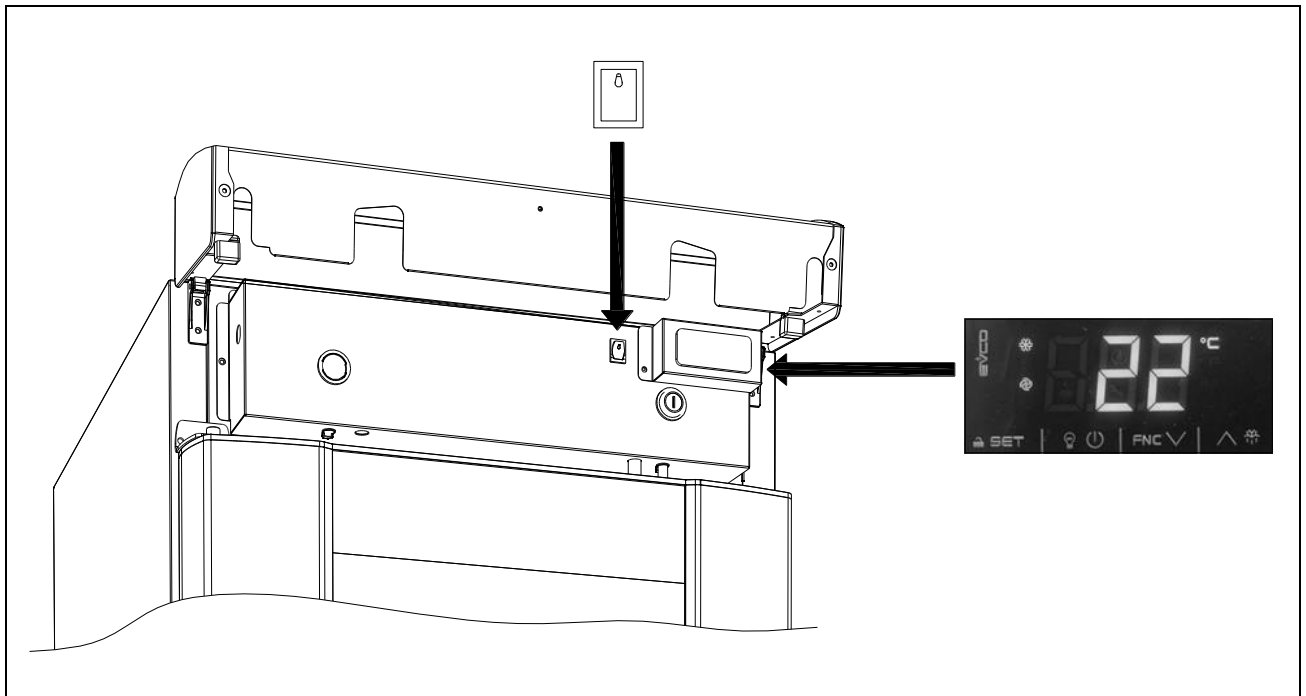





Fig. 6

When the product has been connected to the power supply, but not switched on yet (in standby), this is indicated by a small control lamp  which is the only one lit in the lower right corner of the display.

To switch the product on, press  for approx. 3 seconds. During start-up, the control lamp  will blink until the product is on.

The display will show the current temperature in the product. This also serves to indicate that the power supply is connected to the product.



The product is switched off in the same manner as it is switched on. By pressing  for approx. 3 seconds.



To switch on and off both the interior light in the product and the light in the display box, above the door, use the switch placed immediately to the left of the controls behind the display box. To gain access to this switch, rotate the display box upwards as shown in Fig. 6.



## Temperature setting

Set the desired cabinet temperature in the following manner:

It is important to make sure first that the keyboard is not locked. See how in the section below on keyboard locking.

Press the  key. The compressor lamp  blinks, and the current cabinet temperature setting is shown in the display. This indicates that the current temperature setting can be changed now in the following manner:

Press  or  to raise or lower, respectively, the temperature setting to the desired level.

Once the desired cabinet temperature has been set, press the  key again to save the new value. The compressor lamp  will go out, unless the compressor is running.

Alternatively, by not touching the keys for a minimum of 15 seconds, the controls will switch back to the normal temperature display, and the value that has been set will be saved automatically.

In the event of an interruption to the power supply, the controls will remember the temperature setting, and the product will start up again when the power comes back.

## Keyboard lock

The keyboard is automatically locked when it has not been used/operated for 30 seconds. This secures the product against unauthorised/inadvertent changes to the settings or switching off of the controls.

To unlock the keyboard:

Briefly press . If the display subsequently shows **Loc** then the controls are locked. To unlock the controls, press any key for approx. 3 seconds, until the display shows **UnL**. The display is now unlocked and new settings can be entered.

## Alarms

The controls can show alarms that are related to the settings for the controls or the product's operation.

The following alarms can occur:

- AH** High temperature alarm. This code is shown in the display if the cabinet temperature is too high in relation to the product's set point. The alarm is automatically reset when the correct temperature is re-established.
- AL** Low temperature alarm. This code is shown in the display if the cabinet temperature is too low in relation to the product's set point. The alarm is automatically reset when the correct temperature is re-established. (This alarm is only shown in KG models).
- id** Door alarm. This code is shown in the display if the door has been open for a long time. When the door is closed, this alarm is automatically reset.
- COH** Condenser overheated. This code is shown in the display if the condenser temperature has been too high. Clean the condenser filter in front of the condenser. (Refer to the placement of the filter in Fig. 3).
- CSd** Compressor shut off. This code is shown in the display if the condenser temperature has been so high that it could damage the compressor. The compressor shuts off when this error is shown. To restart the system, do the following:
- Clean the condenser filter in front of the condenser. (Refer to the placement of the filter in Fig. 3). To reset this error, it is necessary to switch the product off and on again. The error is not reset automatically.
- dFd** Defrosting alarm. This code is shown in the display if the defrosting has been interrupted at the maximum time allowed for a defrosting. The product will in all probability continue to function normally. This is just an indication that the product is being or has been subjected to a greater load than the defrosting parameter settings are able to accommodate. This error is acknowledged by touching any key.

## Error codes on the display

- Pr1** If Pr1 is shown in the display, it means that there is an error on the temperature sensor in the product, and service assistance should be summoned.  
The product will in the meantime attempt to maintain the set temperature.
- Pr2** If the display is showing Pr2, there is an error with the evaporator sensor. The sensor should be replaced as soon as possible. Summon service assistance.
- Pr3** If Pr3 is shown in the display, it means that there is an error with the temperature sensor in the condenser, and service assistance should be summoned.  
The product will in the meantime attempt to maintain the set temperature.

### Control lamps:

The display contains the following control lamps:



Control lamp for compressor. Lit when the compressor is in operation. Blinks while the temperature is being set, or if the compressor start has been delayed (compressor protection).



Control lamp for defrosting. Lit continuously during defrosting. Blinks while draining after completed defrosting.



Control lamp for evaporator fan. Lit continuously when the evaporator fan is in operation. Blinks during delay of fan operation.

**AUX** Control lamp for operation of cabinet heating elements. Lit continuously when cabinet heating elements are in operation (Frame, glass and drainage heating elements). This is only for freezers with glass doors (FG models).



Control lamp for compressor operating time. When this control lamp is lit, it means that the compressor has been running for so many hours that it is time to clean the condenser's filter, which is located immediately in front of the condenser. (Refer to the placement of the filter in Fig. 3). When the filter has been cleaned and remounted, the counter that shows the interval must be reset.



This control lamp is the only one in lit in the display when the product is functioning in the state termed low consumption. To see further function indicators and the temperature in the display, it is necessary to press one of the buttons on the controls.

## Troubleshooting

### Noise:

- If abnormal noise occurs, request service assistance.
- Operating sounds from compressor, condenser fan and interior fan are normal. Some models are equipped with a drain pump.
- If sheet metal parts, front panels or panels in front of the compressor compartment are making noise, these might be open. Close the panels.

### Frosting inside compartment:

- Ambient humidity too high.
- The door is opened too often.
- The door is left open for too long.
- Damaged door gasket. Check it thoroughly for damages.

### Poor cooling performance:

- Ambient temperature too high.
- The door is opened too often and/or open for too long.
- The door is left open.
- Damaged door gasket.
- Temperature setting too high.
- Product too packed with foods - air inlet/outlet blocked.
- Condenser air filter is clogged.
- Warm or hot foods inside the product.
- Defrost in progress. The cabinet temperature may rise temporarily during the defrost cycle, but it will not affect the foods inside. The defrost symbol  is displayed.



**Some of the foods are frozen:**

- Product too packed with foods - air inlet/outlet blocked.
- Temperature setpoint too low.
- Evaporator fan might be defective.

**Condensation around the door:**

- Ambient humidity too high.
- The door is not closed tightly.
- Damaged door gasket.

**Too high energy consumption:**

- Ambient temperature too high.
- The door is opened too often and/or open for too long.
- The door is left open.
- Damaged door gasket.
- Temperature setpoint too low.
- Product is too packed with foods - air inlet/outlet blocked.
- Condenser air filter is clogged.
- Warm or hot foods are brought into the product.
- Product is placed in direct sunlight or close to heat-emitting surfaces.
- The default settings have been changed.

## Defrosting

### KG:

Defrosting is automatically performed 4 times every 24 hours, by circulating the air inside the cabinet during a forced standstill of the compressor. The defrost LED  lights to indicate the defrosting cycle is running.



### FG:

Defrosting is automatically performed 4 times every 24 hours, by a defrost heating element.

### Manual defrosting:

If the cabinet is operating under severe load (frequent door opening and frequent replenishment), manual defrosting can become necessary.

Manual defrosting is performed as follows:

Push  for 4 seconds, and defrosting is started. The defrost LED  lights to indicate the defrosting cycle is running.



Do not use sharp or pointed objects to accelerate the defrosting process.

## Defrost water

Defrost water is led through a tube in the insulation, to a tray in the compressor compartment.

A re-evaporation pipe from the refrigeration system, placed in the tray, evaporates the defrost water.



It is recommended to clean the tray and corresponding parts at least once a year. Remember to disconnect the cabinet before cleaning. Be careful not to damage piping parts and heating element during cleaning.

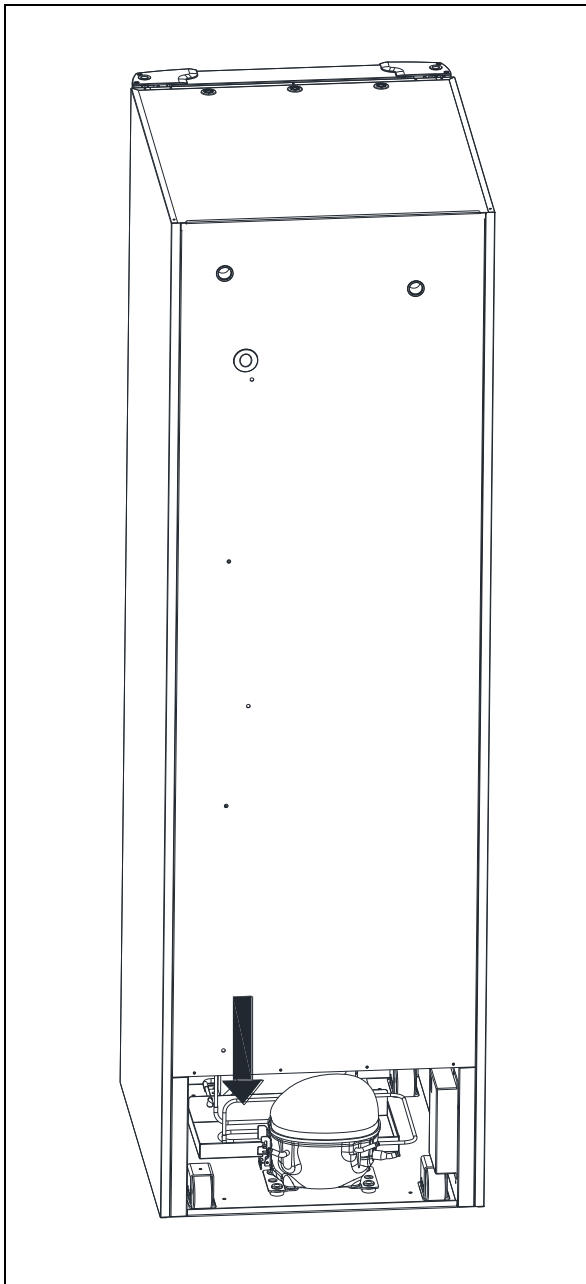

Fig. 7

## Door closing mechanism

The door is equipped with a self-closing system. If the door is opened less than 90°, it will close by itself. If the door is opened more than 90°, it will stay open.

The door can be opened by using the foot pedal. This leaves both hands free when placing foodstuffs the cabinet.

## Power failure

In the event of a power failure, the control remembers the temperature setting and restarts the product when power is restored. If the power failure persists for some time, the control might revert to the factory setting.

## Cleaning

Insufficient cleaning will cause that the product will not work at optimum performance, or eventually it will be defective.



Before cleaning, the product should always be disconnected.



Do not flush the product with water, do not use water jet or steam hose as this may cause short-circuits in the electrical system.



Cleansing agents containing chlorine or compounds of chlorine as well as other corrosive means, **are not to be used**, as they might cause corrosion to the stainless panels of the cabinet and the evaporator.



The compressor compartment and in particular the condenser must be kept free from dust and dirt. This is best done with a vacuum cleaner and a brush. The air filters on the condenser and the front panel can be removed and cleaned in a dishwasher at max. 50°C.



For the external maintenance – use stainless steel polish.



The product should be cleaned internally with a mild soap solution at suitable intervals and checked thoroughly before it is put into operation again.

## Door gaskets

This chapter deals with the importance of a well-functioning door gasket.

Gaskets are an important part of a refrigerator/freezer. Gaskets with reduced functionality, reduces the tightness of the cabinet. Reduced tightness might cause increased humidity, internal icing, an iced up evaporator (leading to reduced refrigeration capacity), and in worst case reduced lifecycle of the cabinet.



Therefore it is important to be aware of the condition of the gasket. Regular inspection is recommended.

The gasket should be cleaned regularly with a mild soap solution.

If a gasket needs replacement, contact your supplier.

## Long term storage

If the product is taken out of operation, and need to be prepared for long-term storage, clean the inside compartment, the door and door gasket thoroughly with a hot soapy damp cloth.

Eventual remnants of food could create mould.

## Service

The refrigerating system and the hermetically sealed compressor require no maintenance - they merely have to be kept clean.

If refrigeration fails, first investigate whether the unit has been unintentionally disconnected or switched off at the socket, or whether a fuse has blown.

If it is not possible to find the cause of the refrigeration failure, please contact Gram service department.

When contacting us please tell us the name and serial number (S/N) / (WWYY) of the cabinet. This information is stated on the name plate, see Fig. 8.

Location of the name plate:

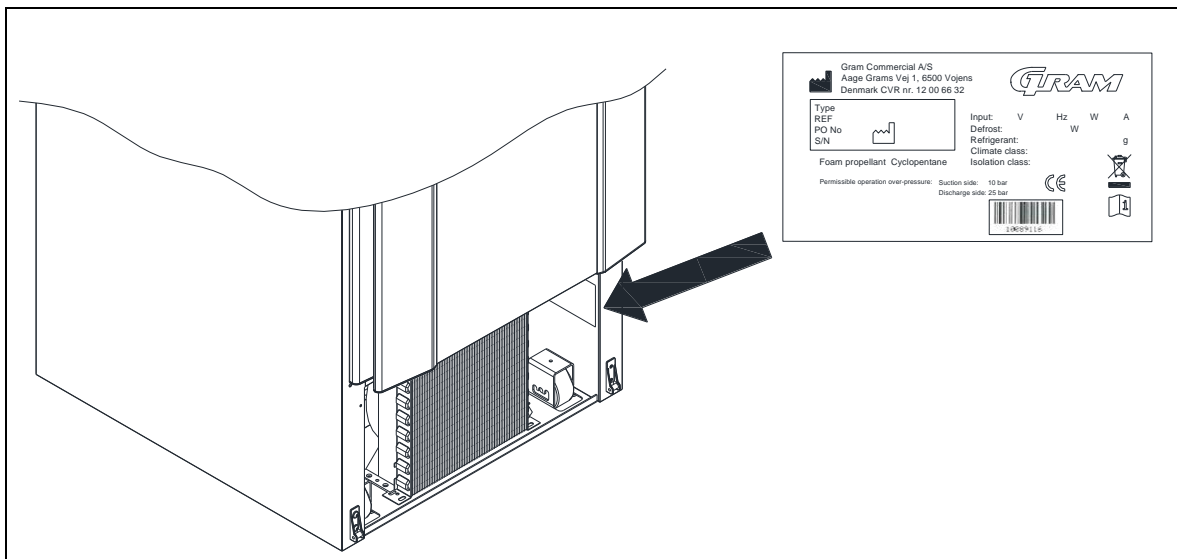

Fig.8

## Disposal

The below only concerns the United Kingdom.

Disposal of an old cabinet is only available when we are delivering a new one at the same time. Cabinets must be fully defrosted and emptied prior to collection.

Gram recognises that our products for the catering market are considered as WEEE when they become obsolete. To ensure that Gram's responsibilities are handled correctly and environmentally friendly, we are signed up the largest Business to Business compliance scheme in the UK – B2B Compliance  
<http://www.b2bcompliance.org.uk>

B2B Compliance will on our behalf deal with all areas of our responsibilities when collecting and disposing of equipment which fall under the UK WEEE regulations. B2B Compliance can be contacted on telephone number 01691 676124.

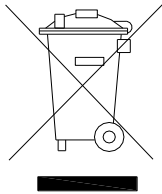

# EC-Declaration of conformity

We, **Gram Commercial A/S**, declare under sole responsibility that the following products:

Name: **Plus Eco 70, Plus Superior 72,  
Twin Eco 82, Twin Superior 84, Combi Twin 82  
Euro Eco 60, Euro Superior 62  
Midi Eco 60, Midi Eco 82**

Refrigerant: R134a, R404A, R290, R600a

To which this declaration relates, is in compliance with all the applicable essential requirements, and other provisions of the European Council Directive.

## Directive of the European Parliament and of the Council:

- Pressure Equipment Directive 97/23/EF
- Directive for Machinery 2006/42/EF
- Low voltage Directive 2006/95/EF
- EMC Directive 2004/108/EF
- RoHS Directive 2002/95/EF
- Atex Directive 94/9/EF

## **Gram Commercial A/S**

Aage Grams Vej 1

DK-6500 Vojens

Telephone: + 45 73 20 12 00

Vojens, 18. february 2014



John Lund  
R&D Manager



# Wiring diagram

